

FINAL REPORT

Bilateral comparisons of reference switching impulse voltage measuring systems

COOMET 707/RU-a/16
(COOMET.EM-S21)
VNIIMS – PTB

N. Boyarin¹, T. Dubrovskaya¹, K. Ermakov¹, V. Kiselev¹, G. Krzywania², J. Meisner².

Pilot laboratory:

¹ Russian research institute for metrological service (VNIIMS)

Contacts:

Victor Kiselev, Nikolay Boyarin, Tatiana Dubrovskaya, Kirill Ermakov

Address: Ozernaya str., 46, 119361 Moscow, **Russian Federation**

e-mail: kiseliev@vniims.ru, dubrovskaya_ta@mail.ru

Phone: +7 (495) 781-28-70, 781-84-25;

Fax: +7 (495) 781-28-70

NMIs:

² Physikalisch-Technische Bundesanstalt (PTB)

Contacts:

Johann Meisner, Gerrit Krzywania

Address: Bundesallee,100, D-38116 Braunschweig, **Germany**,

e-mail: johann.meisner@ptb.de, gerrit.krzywania@ptb.de

Phone: +49 (0)531-592-2320;

Fax: +49 (0)531-592-2309

Abstract – The bilateral comparisons of reference switching impulse voltage measuring systems have been performed between two national metrological institutes (NMIs): VNIIMS and PTB. Its description and measurement results are presented below.

Index Terms – Comparisons, standard uncertainty, measurement, transfer standard, switching impulse voltage.

I. INTRODUCTION

Comparisons were being carried out in 2016 – 2017 under COOMET project 707/RU-a/16 (COOMET.EM-S21).

The Pilot laboratory of the comparisons was FGUP “VNIIMS”. The comparisons were performed with FGUP “VNIIMS” transfer standard in PTB laboratory using measuring equipment of VNIIMS and PTB.

This report includes a brief outline of methods of measurement, procedure of calculations, processing of results of measurements, and presentation of results of comparisons of national reference switching impulse voltage measuring systems. The nominal values of time parameters were 250/2500 μ s in the range from 0,5 kV to 100 kV. The present comparisons were performed in two steps: low voltage measurements and high voltage measurements:

Step 1 - a low voltage (experimental) part of the comparisons includes measurements of time parameters with nominal values of 250/2500 μs in the voltage range from 0,5 kV to 1 kV ¹;

Step 2 - a high voltage part of the comparisons includes measurements of voltage amplitude in the voltage range from 5 kV to 100 kV.

II. COMPARISONS EQUIPMENT

COMPARISONS EQUIPMENT FOR STEP 1

For Step 1 of the comparisons NMIs made available national reference systems with the following metrological characteristics:

For **Step 1 VNIIMS** used the reference switching impulse voltage measuring system of VNIIMS (hereinafter referred as – VNIIMS reference standard) which consists of the following components:

- **Recorder of microsecond impulses RESURS-RIE** with the specific software for registration and calculation of values of the amplitude (U_a) and time parameters: peak time (T_p) and time-to-half value (T_2) of the impulse. Technical characteristics of the impulse recorder RESURS-RIE are represented in Table 1.

Table 1.

Range of amplitude of impulse voltage measurement, V	0,1 ... 1600
Expanded uncertainty $U_{0,95}$ for amplitude at SI	0,1 %*
Expanded uncertainty $U_{0,95}$ for time parameters at SI (**)	0,3%*

* These uncertainties are not approved so far;

** CMC entries for time parameters without a divider do not exist so far

- Generator of standardized single switching and lightning voltage impulses

(hereinafter referred as GSI) – sample of VNIIMS laboratory (Russian Federation).

To perform the comparisons, a single voltage impulse generator was used to generate switching impulse in the range from 0,5 kV to 1 kV. This is necessary to analyze time parameters of the standardized switching impulse voltage with nominal value of 250/2500 μs , using simultaneously the standard equipment of VNIIMS and PTB. Technical characteristics of the GSI are represented in Table 2.

Table 2.

Range of amplitude of impulse voltage measurement, V	100 ... 1000
Fixed waveforms of SI impulse voltage, μs	25/2500; 50/1000; 500/10000
Fixed waveforms of LI impulse voltage, μs	1,2/50; 5/250
Polarity	Positive and negative

¹ The present comparisons were primarily aimed to confirming the measuring and calibration capabilities of participating NMIs in the field of measuring the amplitude of the high voltage switching impulse.

The comparison program did not imply the task of measuring time parameters over the entire voltage range. At the same time, there was a successful experiment during which time parameters with nominal values of 250/2500 microseconds were tested at low voltage in the range from 0,5 kV to 1 kV.

For the present measurements as part of the VNIIMS mobile standard, the installation of a calibrated circuit of 118 Zener – diodes (D818) with series connection was used, while for high-precision measurements of the time parameters of a switching impulse with the uncertainty stated in IBWM, another VNIIMS standard lightning and switching impulse voltage measuring system which includes a reference voltage divider should be used. The voltage divider was not sent to the PTB high-voltage laboratory for comparisons, since there was no task of investigation time parameters during high-voltage measurements.

For **Step 1 PTB** used the reference switching impulse voltage measuring system of PTB which consists of the following components:

- **Transient recorder National Instruments NI PXI 5124** (digitizing signal analyzer). Additionally, an optional 200:1 input divider from Highvolt was used. The impulse evaluation software was PTB's own software "HV impulse 2v50".

- Second **transient recorder** was a **Dr. STRAUSS Tras200-14**. The measuring system has two channels with each 200MS/s and 14-bit digitizer. Both channels have an optional 200:1 internal divider.

- **Lightning and switching impulse voltage calibrator Dr. Strauss KAL 1000**. Technical characteristics of the calibrator Dr. Strauss KAL 1000 are represented in Table 3.

Table 3.

Maximum amplitude of impulse voltage, V	1000
Fixed waveforms of SI impulse voltage, μ s	20/4000
Fixed waveforms of LI impulse voltage, μ s	0,84/60
Polarity	Positive and negative

Since the LI and SI measuring system consists of dividers, cables and transient recorders, the uncertainty is always calculated for the entire system. Table 4 shows the uncertainties for the peak values and time parameters at lightning und switching impulses for the voltage range from 10 V to 1600 V.

Table 4.

Expanded uncertainty $U_{0,95}$ for LI time parameters at 10 V – 1600 V	1%
Expanded uncertainty $U_{0,95}$ for LI peak value at 10 V – 1600 V	0.3%
Expanded uncertainty $U_{0,95}$ for SI time parameters at 10 V – 1600 V	1%
Expanded uncertainty $U_{0,95}$ for SI peak value at 10 V – 1600 V	0.3%

COMPARISONS EQUIPMENT FOR STEP 2

For Step 2 of the comparisons NMIs made available national reference systems with the following metrological characteristics:

For **Step 2 VNIIMS** used VNIIMS reference standard which consists of the following components:

- **Differential voltage meter DWINA-100**. Construction of the DWINA-100 is based on two basic components.

The **high voltage block** (hereinafter referred as - **HVB-100**) is the main component of the instrument. It consists of the base frame, one module of 100 kV voltage, and a high voltage shield, and is used to perform high voltage measurements. HVB-100 is used for measuring switching impulse amplitude in the voltage range from 1 kV to 100 kV with the resolution of 1000 V. HVB-100 consists of a dielectric cylinder, metallic flanges, and 100 measuring boards (1000 V each one) connected in series, on which 118 Zener diodes (D818) with series connection are placed. Zener diodes, used for the boards mounting were subjected to the procedure of artificial ageing under higher temperature, ensuring the time stability of the whole device. The number of the boards connected in series may be chosen depending on the level of measurements and may be changed by means of commutation of the boards that are not used. In the frame of the dielectric shield of HVB-100 opposite the 1 kV boards, there are holes provided for blowing over the boards with the purpose of cooling the Zener diodes.

Between the output of the HVB-100 and ground a Zener diode is added to protect the device from a break of the connecting cable. Protection of the **low voltage block** (hereinafter referred as - **LVB-U2/1000**) is also provided by a spark safety gap.

For protection of the Zener diodes from the possible mechanical damage, the dielectric shield in the form of two halves is provided. It also used forced air cooling during the operation of the system.

Connection of the ground cable is provided with help of a protective grounding clamp placed on the housing of the sector of HVB-100 plugs/sockets (copper foil is preferred for the grounding of the whole system).

LVB-U2/1000 is connected in series with HVB-100.

LVB-U2/1000 is framed into a portable housing. The front control panel consists of: plugs/sockets for connection of a digital voltmeter or oscilloscope, slots for regulation of the stabilization current, indicating panels to observe analogue voltage drop on LVB-U2/1000, and indicating panels for measuring the excess of voltage applied to the device under the level of stabilization. On the rear side there is a grounding clamp and the slot for power cable connection. The electric circuit of the LVB-U2/1000 is mounted on a two-sided board with the use of a printed circuit board.

Functionally, the LVB-U2/1000 consists of the following elements:

- current stabilization scheme;
- indication and control scheme;
- protection and signaling scheme;
- power supply block.

The LVB-U2/1000 is used to provide the stability of the current values (current stabilizer or regulator), detection of the differential voltage, and protection of the measuring circuit from the overload.

Technical characteristics of the DWINA-100 are represented in Table 5.

Table 5.

High voltage range of amplitude of switching impulse voltage measurement, kV	1...100
Expanded uncertainty $U_{0,95}$ for amplitude	0,3 %

- Oscilloscope Tektronix TDS 2024 B

The oscilloscope was used to register the switching impulse voltage amplitude.

Technical characteristics of the Oscilloscope Tektronix TDS 2024 B are represented in Table 6.

Table 6.

Range of voltage measurement, V	0 ... 40
Range of time interval measurement, s	0 ... 50

For **Step 2 PTB** used the PTB reference standard which consists of the following components:

- **Standard damped-capacitive voltage divider for voltages up to 300 kV** with a ratio of 2070 and a 50 Ω coaxial cable. Technical characteristics of it are represented in Table 7.

Table 7.

High voltage range of amplitude of switching impulse voltage measurement, kV	1 ... 300
Nominal value of the input electric capacity of the divider, pF	150
Nominal value of the input electric resistance of the divider, Ω	400
Nominal ratio	2070

- **Transient recorder DSA602A Tektronix**, 8 Bit vertical resolution and 1 ns sampling time. The insert of the slot is a two channel 11A32.

- Second **transient recorder** was a **Dr. STRAUSS Tras200-14**. The measuring system has two channels with each 200MS/s and 14-bit digitizer with the voltage ranges from ± 0.05 V to ± 10 V. Both channels have an optional 200:1 internal divider.

- **Lightning and switching impulse generator Haefely 2 MV and 60 kJ generator with 20 stages at each 100 kV**. The 2000 kV load capacitor of the impulse circuit is a Haefely CR 2000 and has a value of 720 pF.

Since the LI and SI measuring system consists of dividers, cables and transient recorders, the uncertainty is always calculated for the entire system. Table 8 shows the uncertainties for the peak values and time parameters at lightning und switching impulses as well as the step response parameters.

Table 8.

Expanded uncertainty $U_{0,95}$ for LI time parameters at 10 V – 1600 V	1%
Expanded uncertainty $U_{0,95}$ for LI time parameters at 1 kV – 1500 kV	2%
Expanded uncertainty $U_{0,95}$ for LI peak value at 10 V – 1600 V	0.3%
Expanded uncertainty $U_{0,95}$ for LI peak value at 1 kV – 300 kV	0.4%
Expanded uncertainty $U_{0,95}$ for SI time parameters at 10 V – 1600 V	1%
Expanded uncertainty $U_{0,95}$ for SI time parameters at 1 kV – 1500 kV	2%
Expanded uncertainty $U_{0,95}$ for SI peak value at 10 V – 1600 V	0.3%
Expanded uncertainty $U_{0,95}$ for SI peak value at 1 kV – 300 kV	0.4%
Expanded uncertainty $U_{0,95}$ for the overshoot of a step response	5%
Expanded uncertainty $U_{0,95}$ for the response time of a step response	5ns
Expanded uncertainty $U_{0,95}$ for the settling time of a step response	20ns

III. MEASURED PARAMETERS

MEASURED PARAMETERS STEP 1

Measured parameters were values of time parameters: peak time (T_p) and time-to-half value (T_2) of standardized single switching impulses of voltage. Difference between the readings during the measurements of time parameters was calculated according to the formulae:

$$\delta(T_p)_{NMI} = \frac{T_{pPTB} - T_{pVNIIMS}}{T_{pVNIIMS}} \times 100 \quad (1)$$

where $\delta(T_p)_{NMI}$ is the difference between the readings of VNIIMS reference standard and the readings of PTB standard, %;

$T_{pVNIIMS}$ – value of the peak time of the standardized single switching impulse measured by VNIIMS reference system, μ s;

T_{pPTB} – value of the peak time value of the standardized single switching impulse measured by PTB reference system, μ s.

$$\delta(T_2)_{NMI} = \frac{T_{2PTB} - T_{2VNIIMS}}{T_{2VNIIMS}} \times 100 \quad (2)$$

where $\delta(T_2)_{NMI}$ is the difference between the readings of VNIIMS reference standard and the readings of PTB standard, %;

$T_{2VNIIMS}$ – value of the time-to-half value of the standardized single switching impulse measured by VNIIMS reference system, μ s;

T_{2PTB} – value of the time-to-half value of the standardized single switching impulse measured by PTB reference system, μ s.

MEASURED PARAMETERS STEP 2

Measured parameters were values of amplitude of standardized single switching impulses of voltage. Difference between the readings during the measurements of amplitude was calculated according to the formula:

$$\delta(U)_{NMI} = \frac{U_{PTB} - U_{VNIIMS}}{U_{VNIIMS}} \times 100 \quad \dots(3)$$

where $\delta(U)_{NMI}$ is the difference between the readings of VNIIMS standard system and the readings of PTB standard, %;

U_{VNIIMS} – value of the amplitude of the switching impulse voltage measured by VNIIMS reference system, kV;

U_{PTB} – value of the amplitude of the switching impulse voltage measured by PTB reference system, kV.

IV. METHODS AND MEASUREMENT PROCEDURE

METHODS AND MEASUREMENT PROCEDURE STEP 1

Preparing the systems for comparisons. Step 1

Before the start of measurements under the 1st step of comparisons, the standard systems of the laboratories of the NMIs participating the present comparisons were calibrated at the usual location used by PTB. The preliminary adjustments of the standard systems for switching impulse voltage measurements in the voltage range from 0,5 kV to 1 kV were performed. The adjustment and calibration were finished immediately before the start of the measurements for the present comparisons. Calibration and measurement procedures are described below.

Calibration of VNIIMS reference system

Calibration of (mobile) reference switching impulse voltage measuring system of VNIIMS was performed by the self-calibration method of the recorder of microsecond impulses RESURS-RIE.

Calibration of PTB standard system for low voltage measurements.

The scale factor as well as the dynamic behavior of the transient recorder were determined by applying a voltage step generated by a reed relay on the input of the recorder. The evaluation of these measurements was undertaken as described in IEC60060.

Measurements procedure. Step 1

Measurements of time parameters of switching impulse during the 1st step of comparisons were performed at the PTB high voltage laboratory.

All the comparison measurements under the protocol of the 1st step of comparisons were made with AC electric voltage with nominal frequency 50 Hz and nominal value of power supply voltage 230 V. Measurements include simultaneous measurement by the VNIIMS reference system and PTB standard of switching impulses, These were generated by the VNIIMS generator of standardized single voltage impulses with appropriate time parameters..

The low voltage part of the comparisons was performed in the voltage range from 0,5 kV to 1 kV. Time parameters of the standardized switching impulse voltage with nominal value of time parameters 250/2500 μ s were registered.

During the measurements, the GSI, mobile standard system of VNIIMS and the PTB standard were connected in parallel, and measurements under the 1st step of comparisons were performed.

Devices were configured for the measurement of impulses with the time parameters 250/2500 μ s. From the impulse generator of VNIIMS the voltage time parameters were set in the range from 0,5 kV to 1 kV at the following levels: 500 V; 600 V; 700 V; 800 V; 900 V and 1 kV.

Then the impulse was initiated. With the start of the impulse according to the readings of the recorders of the measuring systems of VNIIMS and PTB the measured impulse time parameters (T_p and T_2), were fixed (registered).

Before increasing the voltage to the next level, at least ten (10) readings were made, and then the voltage was increased immediately to the next level.

Results were registered in Tables 12-13.

Preparing the systems for comparisons. Step 2

Before the start of measurements under the 2nd step of comparisons, the standard systems of the laboratories of the NMIs participating the present comparisons were calibrated at the usual location used by PTB. The preliminary adjustments of the standard systems for switching impulse amplitude voltage measurements in the voltage range from 5 kV to 100 kV were performed. The adjustment and calibration were finished immediately before the start of the measurements for the present comparisons. Calibration and measurement procedures are described below.

Calibration of VNIIMS standard system

Calibration of (mobile) standard switching impulse voltage measuring system of VNIIMS is performed by the method of direct measurements.

Result of calibration is detection of the actual value of voltage of stabilization U_{ST} of the differential voltage meter DWINA-100.

Calibration of differential voltage meter DWINA-100 was performed by means of consequent calibration of each 1 kV board of the HVB-100 following the calibration protocol (see Table A.1 in Annex A attached). With the purpose of using DWINA-100 as a part of a standard switching impulse voltage measuring system, it was enough to apply voltage during 30 s (controlled by a stopwatch) and then the registered measured voltage results were compared to the results of the previous calibration.

During calibration of the VNIIMS measuring system, the following auxiliary equipment of PTB was used:

- calibrator FLUKE 5720A – 1 unit;
- standard voltmeter Keithley 2000 – 2 units.

Technical characteristics of the calibrator FLUKE 5720A are represented in Table 9.

Table 9.

Upper level of measurement of DC voltage, V	1100
Absolute uncertainty for DC voltage measurement, \pm ppm	8,5

Technical characteristics of the standard voltmeter Keithley 2000 № 429650 are represented in Table 10.

Table 10.

DC voltage measurement range, V	10-1000
Absolute uncertainty, \pm ppm	51

Technical characteristics of standard voltmeter Keithley 2000 № 0611207 are represented in Table 11.

Table 11.

Upper level of measurement of DC voltage, V	10
Absolute uncertainty, \pm ppm	35

The HVB-100 and LVB-U2/1000 were connected to the auxiliary equipment for calibration performing according to the configuration represented in Picture 1.

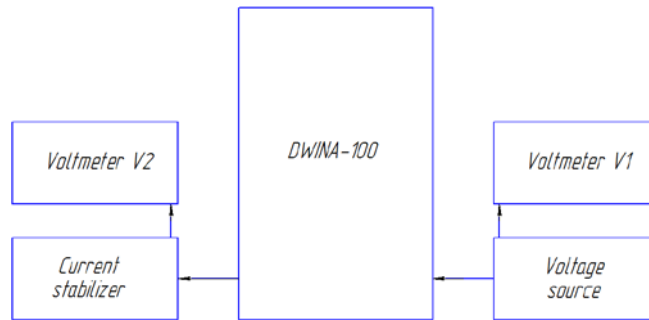

Figure 1 – Configuration of equipment for DWINA-100 calibration.

A photo of the calibration of the VNIIMS standard measuring system based on the differential meter DWINA-100 at PTB is represented in Figure A.1 in Annex A.

Calibration of the PTB standard system

The scale factor of PTB's 300 kV damped-capacitive divider including the 25m RG214 cable was measured directly before the comparison using a Fluke 5720A calibrator at 500 V and 1 kHz as well as two calibrated Keithley 2000 voltmeters (represented in Figure 6; technical characteristics in Tables 7 and 8 above). The divider was connected to the load capacitor of the high voltage circuit and was placed at this position for the comparison. One of the Keithley voltmeters was used to capture the output voltage of the generator (input voltage of the divider) directly, the second Keithley voltmeter was used to capture the output voltage of the divider. This step was repeated after interchanging the Keithley voltmeters. The average of the results of the scale factors was used as the final scale factor for the comparison. The measured scale factor was 2072.

The scale factor as well as the dynamic behavior of the transient recorder were determined by applying a voltage step generated by a reed relay on the input of the recorder. The evaluation of these measurements was undertaken as described in IEC60060.

Measurements procedure. Step 2

Measurements of the amplitude of the switching impulse during the 2nd step of comparisons were performed at the PTB high voltage laboratory. Photos of the standard measuring systems of VNIIMS and PTB placed in the high voltage laboratory during the 2nd step of comparisons are represented on Figure A.2 in Annex A.

All the comparison measurements under the protocol of the 2nd step of comparisons were made with AC electric voltage with nominal frequency 50 Hz and nominal value of power supply voltage 230 V. Measurements included simultaneous measurement of switching impulse amplitude, generated by PTB generator of standardized single voltage impulses, by the VNIIMS reference system and the PTB standard.

The high voltage part of the comparisons was performed in the voltage range from 5 kV to 100 kV. During the measurements the impulse generator of PTB, the mobile standard system of VNIIMS and PTB standard were connected in parallel, and measurements under the 2nd step of comparisons were performed.

Devices were configured for the measurement of impulses with the time parameters 250/2500 μ s. From the impulse generator of PTB the output voltage amplitude was set in the range from 5 kV to 100 kV at the following levels: 5 kV; 10 kV; 20 kV; 50 kV; 75 kV and 100 kV.

Then the impulse was initiated. With the start of the impulse, according to the readings of the recorders of the measuring systems of VNIIMS and PTB, the measured impulse amplitude (U_a), was fixed (registered).

Before increasing the voltage to the next level, at least ten (10) readings were made, then the voltage was removed, and the GSI was grounded. The VNIIMS measuring system commutation was changed to the following voltage level, where measurements were performed.

Results were registered in Table 14.

Uncertainty of measurement

Both participants provided the uncertainty budget of their standards.

The uncertainty must be evaluated according to uncertainty of measurement – Section 3 of the Guide to the expression of uncertainty in measurement (GUM:1995).

A list of the principal components of the uncertainty budget evaluated by each participant was not included in the technical protocol. It is assumed that each participating laboratory applies a different method depending on its facilities.

V. RESULTS OF COMPARISONS

RESULTS OF COMPARISONS. STEP 1

Results of the measurements under the 1st step comparisons are represented in Tables 12 and 13 (the values were approximated to a significant digit), and graphically on Figures 2 - 5.

Table 12. Results of the measurements and the difference (the mean values) of standardized switching impulse voltage time parameters in the voltage range from 0,5 kV to 1 kV between the VNIIMS reference system and PTB's transient recorder Dr. Strauss TRAS200-14.

Voltage level, V	PTB (Dr. Strauss)		VNIIMS		Difference, %	
	T_p PTB, μ s	T_2 PTB, μ s	T_p VNIIMS, μ s	T_2 VNIIMS, μ s	$\delta(T_p)$	$\delta(T_2)$
500	236,5	3229,1	236	3228,95	0,24	0,05
600	236,6	3227,5	235,33	3228,5	0,6	-0,03
700	236,5	3228,9	238,56	3229,1	-0,8	-0,03
800	236,5	3227,7	235,03	3227,1	0,66	0,02
900	236,5	3227,8	237,06	3223,6	-0,19	0,01
1000	236,3	3229,1	235,51	3225,6	0,39	0,1

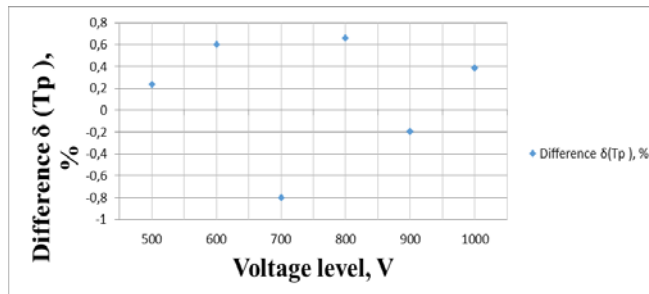

Figure 2 – Results of the peak time of the standardized single switching impulse measurements (VNIIMS reference system - PTB's Dr. Strauss TRAS200-14)

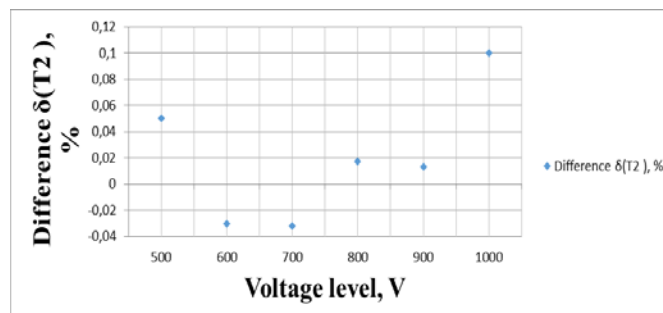

Figure 3 – Results of the time-to-half of the standardized single switching impulse measurements (VNIIMS reference system - PTB's Dr. Strauss TRAS200-14)

Table 13. Results of the measurements and the difference (the mean values) of standardized switching impulse voltage time parameters in the voltage range from 0,5 kV to 1 kV between VNIIMS reference system and PTB's transient recorder National Instruments PXI 5124.

Voltage level, V	PTB (NI PXI-5124)		VNIIMS		Difference	
	T_p NI PXI-5124, μ s	T_2 NI PXI-5124, μ s	T_p VNIIMS, μ s	T_2 VNIIMS, μ s	$\delta(T_p)$, %	$\delta(T_2)$, %
500	237,34	3221,12	237,08	3233,95	0,12	-0,40
600	237,34	3222,59	236,05	3241,50	0,64	-0,58
700	237,43	3224,62	237,65	3235,27	-0,45	-0,33
800	237,39	3225,14	237,03	3231,71	1,01	-0,2
900	237,33	3218,01	237,68	3229,89	-0,53	-0,37
1000	237,32	3218,81	237,92	3230,63	0,25	-0,37

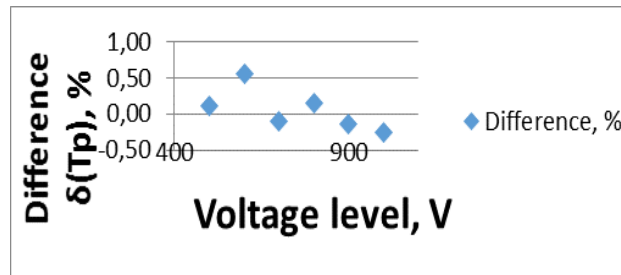

Figure 4 – Results of the peak time of the standardized single switching impulse measurements (VNIIMS reference system - PTB's NI PXI-5124)

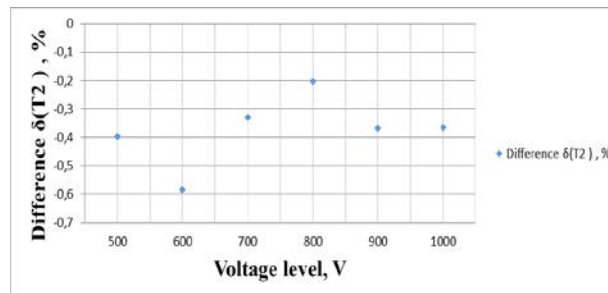

Figure 5 – Results of the time-to-half of the standardized single switching impulse measurements (VNIIMS reference system - PTB's NI PXI-5124)

In Tables 12, 13 the following symbols are used:

T_p PTB, T_p VNIIMS, T_p NI PXI-5124 – values of the peak time of the standardized single switching impulse measurements, μ s;

T_2 PTB, T_2 VNIIMS, T_2 NI PXI-5124 – values of the time-to-half of the standardized single switching impulse measurements, μ s;

$\delta(T_p)$, $\delta(T_2)$, – differences between the values of the participants PTB and VNIIMS, %.

RESULTS OF COMPARISONS. STEP 2

Results of the measurements under the 2nd step comparisons are represented in Table 14 and graphically on Figure 6.

Table 14. Results of the measurements and the difference (the mean values) of standardized switching impulse voltage amplitude in the voltage range from 5 kV to 100 kV.

Voltage level, kV	PTB		VNIIMS		Difference, %
	U _a PTB, kV	U _{0,95} PTB, %	U _a VNIIMS, kV	U _{0,95} VNIIMS, %	
5	5,467	0,4	5,480	0,3	-0,2
10	10,18	0,4	10,19	0,3	-0,1
20	20,40	0,4	20,42	0,3	-0,1
50	50,27	0,4	50,28	0,3	0
75	75,51	0,4	75,36	0,3	0,2
100	100,8	0,4	100,7	0,3	0,1

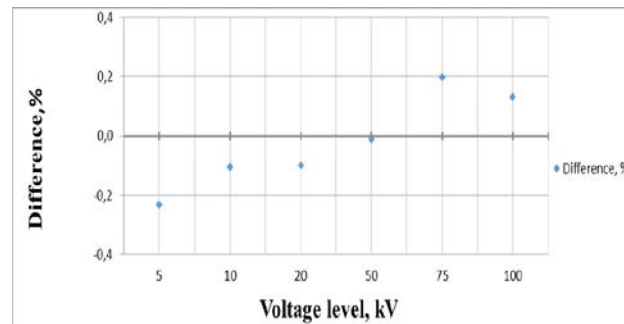

Figure 6 – Diagram of voltage difference between VNIIMS and PTB depending on the voltage level

In Table 14 the following symbols are used:

U_a PTB , U_a VNIIMS – the impulse voltage amplitude, kV;

U_{0,95} PTB , U_{0,95} VNIIMS – expanded uncertainty of NMI U_{0,95} , %.

Analysis of comparison data

The distribution function χ^2 is tabulated. If the received values U_a do not exceed the critical value

$\chi_{0,95}^2(n-1)$ for the confidence level P = 0,95 and number of degrees of freedom (n-1), then that is objective evidence in support of the uncertainties declared by the NMI during the comparisons:

$$\chi_{U_a}^2 < \chi_{0,95}^2(n-1) \quad (4)$$

The degree of equivalence of the NMI standard was defined as the difference of the VNIIMS / PTB standard system in the voltage range from 5 kV to 100 kV, and the average value of amplitude $\Delta(f_L)$ measurements, according to the equation below:

$$\Delta(f_L) = f_L - f_o \quad (6).$$

Methods of data evaluation and the corresponding equations are represented in Annex B. Results of the calculations are represented in the Table C.1 in Annex C.

Graphic results of comparisons for high voltage under step 2 are additionally demonstrated on examples below (Figures 1-6).

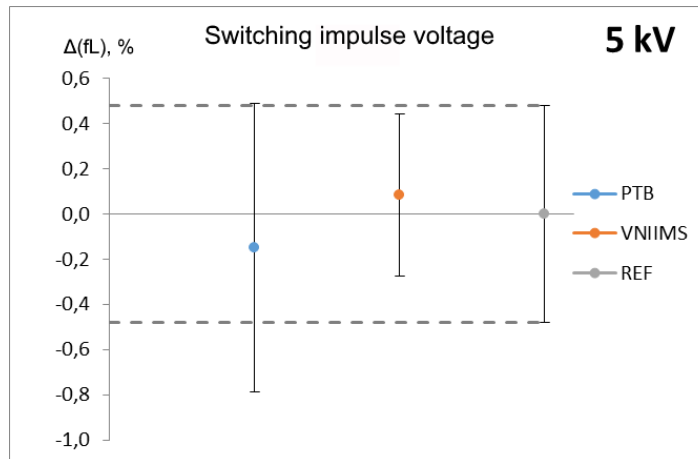

Figure 1 – Differences $\Delta(f_L)$ and their uncertainties for 5 kV.

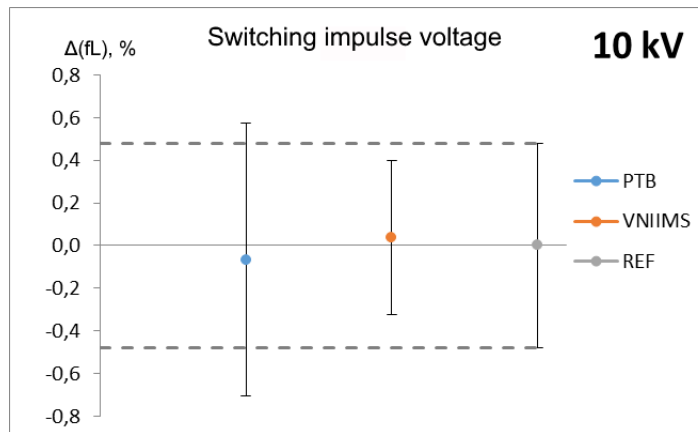

Figure 2 – Differences $\Delta(f_L)$ and their uncertainties for 10 kV.

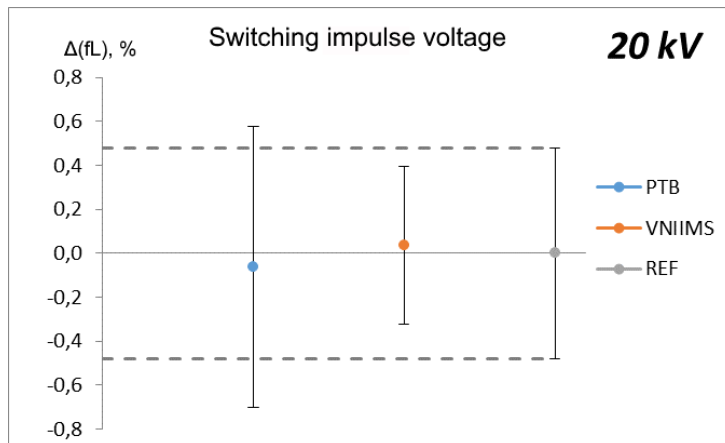

Figure 3 – Differences $\Delta(f_L)$ and their uncertainties for 20 kV.

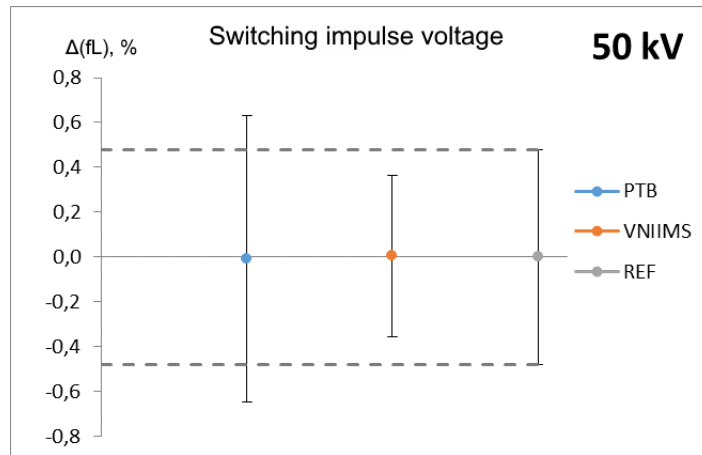

Figure 4 – Differences $\Delta(f_L)$ and their uncertainties for 50 kV.

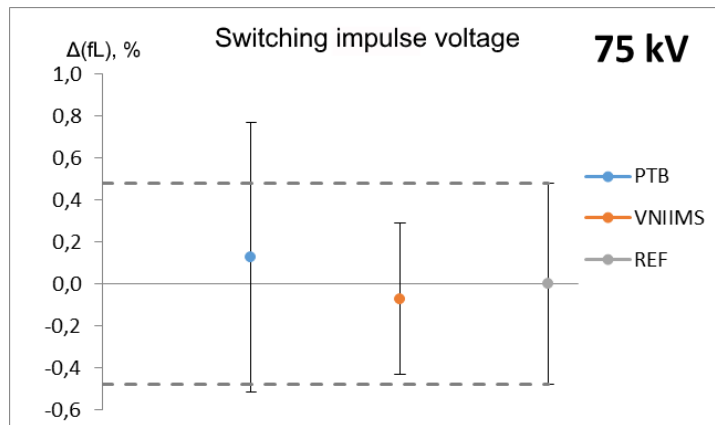

Figure 5 – Differences $\Delta(f_L)$ and their uncertainties for 75 kV.

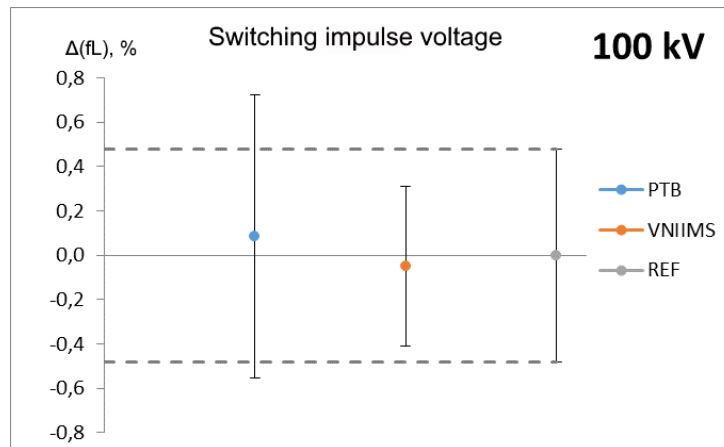

Figure 6 – Differences $\Delta(f_L)$ and their uncertainties for 100 kV.

VII. CONCLUSION

All data presented by NMIs during the measurements, calculation and processing of the results of comparisons is recognized as consistent, being objective evidence in support of the uncertainties declared during the present comparisons under the COOMET project.

This is also the evidence of corresponding calibration and measurement capabilities (CMCs) for the BIPM database for those values of switching impulse voltage with nominal values of time parameters 250/2500 μ s in the range from 0,5 kV to 100 kV .

For NMIs having a better accuracy of measurements than their existing CMCs, the results may be accepted as the grounds for corresponding changes to the BIPM database with the improved uncertainties of the state standards.

Table A.1 – Calibration protocol of the standard measuring system based on differential meter DWINA-100 with DC voltage on 04.07.2017

№ board	04.07.2017			19.04.2017		Result
	U _{v1}	U _{v2}	U _{st(30)} in PTB	U _{st(30)} in VNIIMS	ΔU _{st}	
1	2	3	4	5	6	7
1	1009,999	9,049	1000,950	1000,941	0,009	Valid ¹
2	1009,999	8,324	1001,675	1001,817	-0,142	Valid
3	1009,999	8,829	1001,170	1001,115	0,055	Valid
4	1009,999	9,807	1000,192	1000,201	-0,009	Valid
5	1009,999	9,512	1000,487	1000,499	-0,012	Valid
6	1009,999	7,925	1002,074	1002,1	-0,026	Valid
7	1009,999	12,463	997,536	997,671	-0,135	Valid
8	1009,999	7,297	1002,702	1002,755	-0,053	Valid
9	1009,999	9,921	1000,078	1000,072	0,006	Valid
10	1009,999	10,513	999,486	999,509	-0,023	Valid
11	1009,999	9,587	1000,412	1000,428	-0,016	Valid
12	1009,999	8,691	1001,308	1001,312	-0,004	Valid
13	1009,999	10,201	999,798	999,806	-0,008	Valid
14	1009,999	8,193	1001,806	1001,77	0,036	Valid
15	1009,999	7,07	1002,929	1002,961	-0,032	Valid
16	1009,999	13,033	996,966	997,008	-0,042	Valid
17	1009,999	13,233	996,766	996,801	-0,035	Valid
18	1009,999	9,883	1000,116	1000,156	-0,040	Valid
19	1009,999	8,904	1001,095	1001,134	-0,039	Valid
20	1009,999	11,014	998,985	999,031	-0,046	Valid
21	1009,999	8,684	1001,315	1001,356	-0,041	Valid
22	1009,999	6,846	1003,153	1003,169	-0,016	Valid
23	1009,999	8,168	1001,831	1001,839	-0,008	Valid
24	1009,999	8,939	1001,060	1001,067	-0,007	Valid
25	1009,999	10,144	999,855	999,891	-0,036	Valid
26	1009,999	10,635	999,364	999,334	0,030	Valid
27	1009,999	8,743	1001,256	1001,277	-0,021	Valid
28	1009,999	10,184	999,815	999,847	-0,032	Valid
29	1009,999	13,431	996,568	996,613	-0,045	Valid
30	1009,999	7,289	1002,710	1002,732	-0,022	Valid
31	1009,999	10,88	999,119	999,158	-0,039	Valid

¹ Each 1 kV board with Zener diodes of the DVINA-100 meter has its own tolerance. If, according to the results of calibration (which is performed for this device for each board – the metrological characteristics of each 1 kV board are checked), it is not exceeded, then the board is considered valid.

Proceeding of Table A.1

04.07.2017

19.04.2017

№ board	U_{v1}	U_{v2}	U_{st(30)} in PTB	U_{st(30)} in VNIIMS	ΔU_{st}	Result
1	2	3	4	5	6	7
32	1009,999	10,385	999,614	999,648	-0,034	Valid
33	1009,999	9,604	1000,395	1000,433	-0,038	Valid
34	1009,999	11,399	998,600	998,639	-0,039	Valid
35	1009,999	9,078	1000,921	1000,944	-0,023	Valid
36	1009,999	11,201	998,798	998,837	-0,039	Valid
37	1009,999	9,965	1000,034	1000,074	-0,040	Valid
38	1009,999	9,782	1000,217	1000,258	-0,041	Valid
39	1009,999	8,617	1001,382	1001,413	-0,031	Valid
40	1009,999	10,555	999,444	999,484	-0,040	Valid
41	1009,999	7,023	1002,976	1003,013	-0,037	Valid
42	1009,999	10,796	999,203	999,226	-0,023	Valid
43	1009,999	10,548	999,451	999,482	-0,031	Valid
44	1009,999	10,572	999,427	999,462	-0,035	Valid
45	1009,999	7,403	1002,596	1002,625	-0,029	Valid
46	1009,999	11,546	998,453	998,495	-0,042	Valid
47	1009,999	9,377	1000,622	1000,653	-0,031	Valid
48	1009,999	11,251	998,748	998,779	-0,031	Valid
49	1009,999	10,819	999,180	999,213	-0,033	Valid
50	1009,999	11,962	998,037	998,075	-0,038	Valid
51	1009,999	11,616	998,383	998,417	-0,034	Valid
52	1009,999	11,212	998,787	998,826	-0,039	Valid
53	1009,999	8,957	1001,042	1001,078	-0,036	Valid
54	1009,999	8,048	1001,951	1001,954	-0,003	Valid
55	1009,999	8,517	1001,482	1001,482	0,000	Valid
56	1009,999	8,23	1001,769	1001,804	-0,035	Valid
57	1009,999	10,535	999,464	999,494	-0,030	Valid
58	1009,999	12,273	997,726	997,776	-0,050	Valid
59	1009,999	11,021	998,978	999,021	-0,043	Valid
60	1009,999	13,531	996,468	996,523	-0,055	Valid
61	1009,999	10,128	999,871	999,911	-0,040	Valid
62	1009,999	9,861	1000,138	1000,172	-0,034	Valid
63	1009,999	10,087	999,912	999,95	-0,038	Valid
64	1009,999	11,841	998,158	998,197	-0,039	Valid
65	1009,999	10,742	999,257	999,304	-0,047	Valid
66	1009,999	10,296	999,703	999,754	-0,051	Valid
67	1009,999	11,099	998,900	998,96	-0,060	Valid

Proceeding of Table A.1

№ board	U _{v1}	U _{v2}	04.07.2017	19.04.2017	ΔU _{st}	Result
			U _{st(30)} in PTB	U _{st(30)} in VNIIMS		
1	2	3	4	5	6	7
68	1009,998	10,593	999,405	999,45	-0,045	Valid
69	1009,998	11,621	998,377	998,416	-0,039	Valid
70	1009,998	10,842	999,156	999,19	-0,034	Valid
71	1009,998	10,249	999,749	999,781	-0,032	Valid
72	1009,998	11,769	998,229	998,254	-0,025	Valid
73	1009,997	10,118	999,879	999,913	-0,034	Valid
74	1009,997	14,043	995,954	996,044	-0,090	Valid
75	1009,997	9,261	1000,736	1000,748	-0,012	Valid
76	1009,997	8,898	1001,099	1001,131	-0,032	Valid
77	1009,997	9,273	1000,724	1000,736	-0,012	Valid
78	1009,997	10,253	999,744	999,773	-0,029	Valid
79	1009,997	11,192	998,805	998,846	-0,041	Valid
80	1009,997	10,668	999,329	999,361	-0,032	Valid
81	1009,997	11,238	998,759	998,785	-0,026	Valid
82	1009,997	12,447	997,550	997,597	-0,047	Valid
83	1009,997	11,233	998,764	998,805	-0,041	Valid
84	1009,997	8,874	1001,123	1001,168	-0,045	Valid
85	1009,997	9,047	1000,950	1000,97	-0,020	Valid
86	1009,997	8,471	1001,526	1001,576	-0,050	Valid
87	1009,997	10,706	999,291	999,33	-0,039	Valid
88	1009,997	10,729	999,268	1002,663	-3,395	Valid
89	1009,997	10,014	999,983	1000,026	-0,043	Valid
90	1009,997	11,127	998,870	998,903	-0,033	Valid
91	1009,997	10,177	999,820	999,863	-0,043	Valid
92	1009,997	11	998,997	999,03	-0,033	Valid
93	1009,997	12,465	997,532	997,57	-0,038	Valid
94	1009,998	11,57	998,428	999,059	-0,631	Valid
95	1009,998	9,504	1000,494	1000,526	-0,032	Valid
96	1009,998	8,955	1001,043	1001,043	0,000	Valid
97	1009,998	11,401	998,597	998,631	-0,034	Valid
98	1009,999	10,375	999,624	999,667	-0,043	Valid
99	1009,999	8,927	1001,072	1001,065	0,007	Valid
100	1009,999	10,294	999,705	1000,745	-1,040	Valid
			Total: boards to check		0	Units

where:

U_{v1} – primary voltage, V;

U_{v2} – secondary voltage, V;

$U_{st(30)}$ in PTB – stabilisation voltage, V, of 1 kV board for 30 s, measured in PTB laboratory;

$U_{st(30)}$ in VNIIMS – stabilisation voltage, V, of 1 kV board for 30 s, measured in VNIIMS laboratory;

ΔU_{st} – difference between stabilisation voltages, V, of 1 kV board, measured in VNIIMS laboratory and in PTB laboratory.

Below you may find some pictures from the present comparisons in PTB high voltage laboratory, including calibration of VNIIMS standard measuring system based on differential meter DWINA-100.

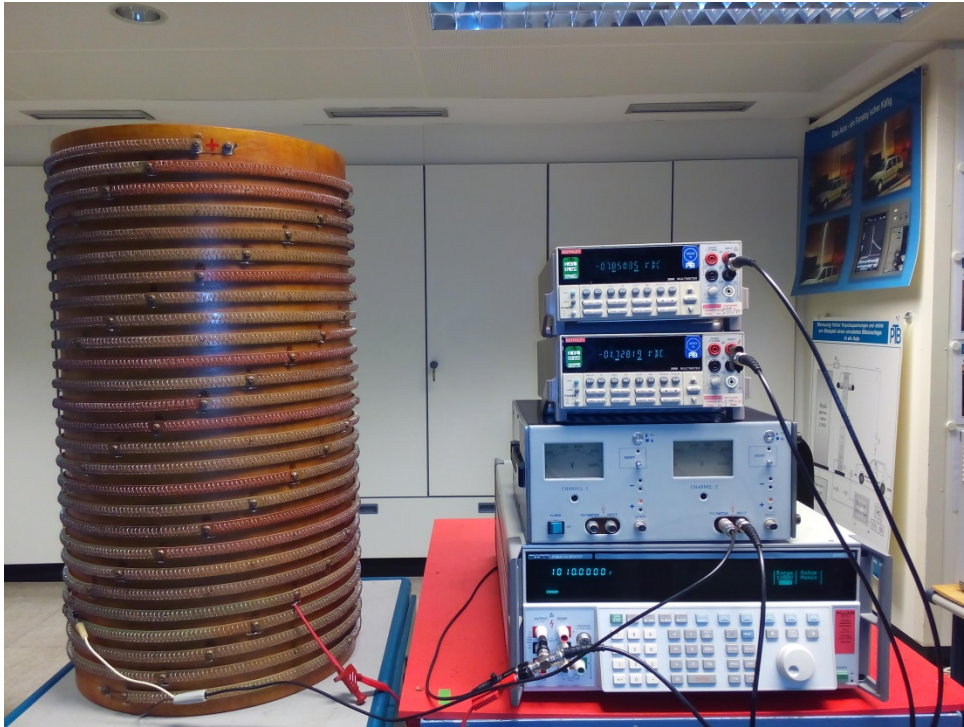

Picture A.1 Calibration of VNIIMS standard measuring system based on differential meter DWINA-100 in PTB

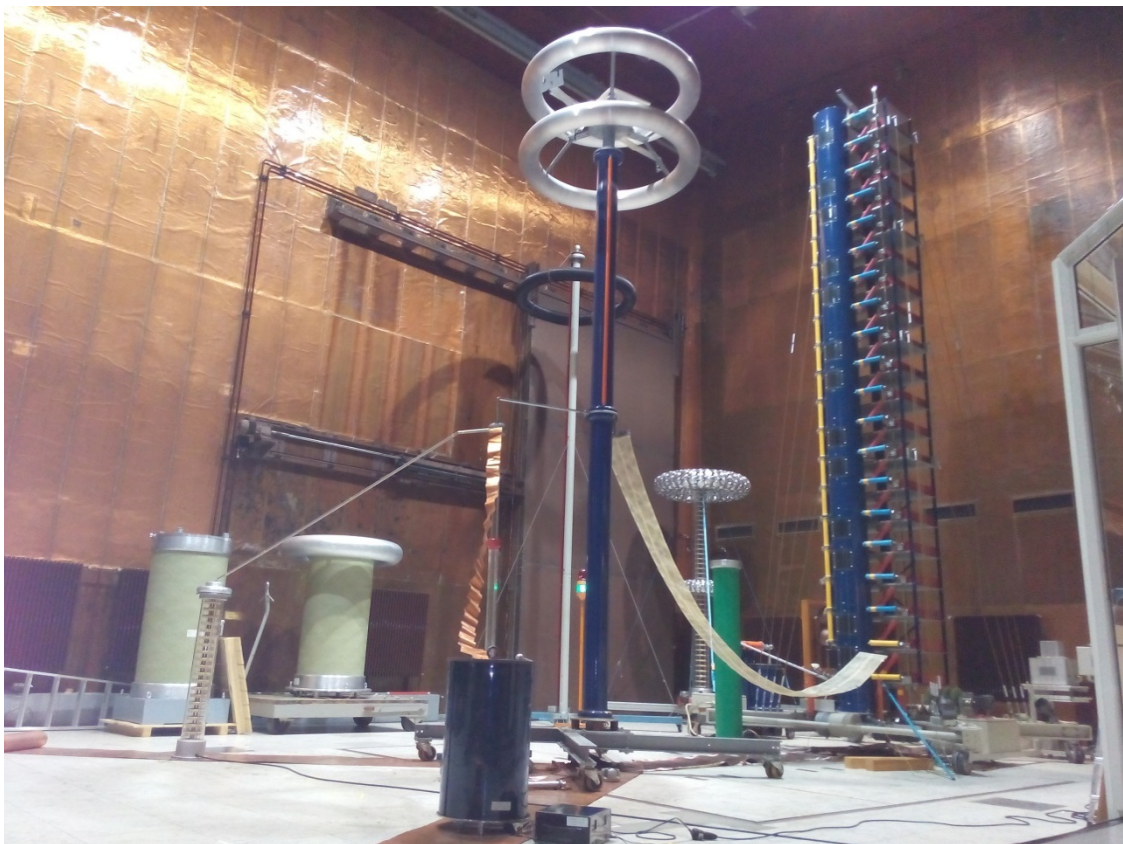

Picture A.2.1



Picture A.2.2

Picture A.2 Standard measuring systems of VNIIMS and PTB placed in high voltage laboratory during the 2nd step of comparisons

SUPPLEMENTARY COMPARISON DATA EVALUATION

Processing of comparison data and all calculations were made in correspondence with the normative documents and regulations according to the following equations.

For each combination of voltage steps the resulting comparison reference value (CRV) is calculated as the weighted average according to the formulae:

$$f_o = \frac{\sum_{L=1}^n f_L \cdot u^{-2}(f_L)}{\sum_{L=1}^n u^{-2}(f_L)}, \quad (\text{B-1})$$

where f_o - average value of measurement of deviation of switching impulse voltage;

f_L - results of measurement of deviation of switching impulse voltage of each participating laboratory;

$u(f_L)$ - combined standard uncertainty of measurement of deviation of switching impulse voltage of each participating laboratory;

n - the number of participating laboratories.

The combined standard uncertainty of the average value of deviation of switching impulse voltage $u(f_o)$ is given by the formula:

$$u(f_o) = \frac{1}{\sqrt{\sum_{L=1}^n u^{-2}(f_L)}}, \quad (\text{B-2})$$

Expanded uncertainty of the average value of deviation of switching impulse voltage $U(f_o)$ for a coverage factor $k = 2$ (95 % confidence level) are calculated according to the equations below:

$$U(f_o) = 2u(f_o), \quad (\text{B-3})$$

The difference in the participant's result to the CRV is given by:

$$\Delta(f_L) = f_L - f_o, \quad (\text{B-4})$$

with uncertainty

$$u(\Delta f_L) = \sqrt{u^2(f_L) - u^2(f_o)}, \quad (\text{B-5})$$

The expanded uncertainty of the difference of the average value of deviation of switching impulse voltage $U(\Delta f_L)$ is given by the formula:

$$U(\Delta f_L) = 2u(\Delta f_L), \quad (\text{B-6})$$

The credibility of the reference values and their uncertainties is characterized by the χ^2 test, given by the formula (B-7). Values of this function are determined for the results of switching impulse voltage measurement for each switching impulse voltage level by formula:

$$\chi_f^2 = \sum_{L=1}^n \frac{(f_L - f_o)^2}{u^2(f_L)}, \quad (\text{B-7})$$

f_o - average values for the differences of the measurement results from the switching impulse voltage (equation 4);

f_L - are the differences of the measurement results from the switching impulse voltage for each NMI participating the comparisons;

$u(f_L)$ - are combined standard deviations (standard uncertainties) of the differences of measurements results from switching impulse voltage, represented by each NMI participating in the comparison;

n - is a number of NMIs participating in the comparisons (equals 2 for bilateral comparisons).

The results of the participating NMI may be regarded as satisfactory if χ^2 is smaller than the critical value for the confidence level 0,95 and for $n-1$ degrees of freedom, that is the objective confirmation of the declared uncertainties.

χ^2 is related to the Birge Ratio R_B as follows:

$$\chi^2 = R_B^2 \cdot (n - 1). \quad (\text{B-8})$$

The consistency is usually regarded as satisfactory if the probability of having a χ^2 greater than the observed one is smaller than 5 %. For 1 degree of freedom ($n = 2$), the corresponding upper value for the χ^2 -test is 3,8 (deduced from the χ^2 -test distribution function). This corresponds to a value of $R_b=1,95$. Combining equations (B-7) and (B-8), we get:

$$R_B = \sqrt{\frac{\sum_{L=1}^n u^{-2}(f_L) \cdot (f_L - f_o)^2}{n - 1}}, \quad (\text{B-9})$$

Those results of U_a are chosen that under all voltages, corresponded the inequality:

$$R_B > 1,95, \quad (\text{B-10})$$

For all the AC voltage values corresponding the inequality (B-10), confidence coefficients of the results of deviation of switching impulse voltage $E_n(f_L)$ measurements should be calculated according to the formula:

$$E_n(f_L) = \frac{|\Delta f_L|}{U(\Delta f_L)}, \quad (\text{B-11})$$

The results of the laboratories with confidence coefficient $E_n > 1,5$ should not be included in the calculation of the corrected comparison reference values and their uncertainties.

$$E_n(f_L) > 1,5, \quad (\text{B-12})$$

The corrected comparison reference values (without eliminated results) according to the formulae (B-1), and their combined standard uncertainties - according to the formula (B-2), and also expanded uncertainties of the comparison reference values according to the formula (B-3). Still the last three formulae (B-11–B-13) are not so important for bilateral comparisons.

The degree of equivalence of each national standard, is the degree up to which the value of the national standard measuring corresponds the reference value. It is expressed as the deviation of the measurement results from the reference value for the difference of deviation of switching impulse voltage $\Delta(f_L)$ according to the formula (B-4) and as expanded uncertainties of deviation according to the formula (B-6).

For NMI measurement results of which are not included into the calculation of the comparison reference value, have the uncertainties calculated according to the formulae:

$$U'(\Delta f_L) = 2\sqrt{u^2(f_L) + u^2(f_o)}, \quad (\text{B-13}).$$

**STEP 2. Results of measurements of standardized switching impulse voltage amplitude
with nominal values of time parameters 250/2500 μ s, (U_a), by standard systems of VNIIMS and PTB**

Table C.1 – Results of measurements of standardized switching impulse voltage amplitude with nominal values of time parameters 250/2500 μ s, (U_a), by standard systems of VNIIMS and PTB

Voltage level, kV	f_0 , %	$u(f_0)$, %	$U(f_0)$, %	$\Delta(f)$ PTB %	$\Delta(f)$ VNIIMS %	$u(\Delta f)$, PTB %	$u(\Delta f)$, VNIIMS %	$U(\Delta f)$, PTB %	$U(\Delta f)$, VNIIMS %	χ^2_f	R_B	En (PTB)	En (VNIIMS)
5	-0,08389	0,24000	0,48000	-0,14914	0,08389	0,32000	0,18000	0,64000	0,36000	0,43440	0,65909	0,23302	0,23302
10	-0,03777	0,24000	0,48000	-0,06714	0,03777	0,32000	0,18000	0,64000	0,36000	0,08805	0,29674	0,10491	0,10491
20	-0,03514	0,24000	0,48000	-0,06247	0,03514	0,32000	0,18000	0,64000	0,36000	0,07622	0,27608	0,09761	0,09761
50	-0,00417	0,24000	0,48000	-0,00740	0,00417	0,32000	0,18000	0,64000	0,36000	0,00107	0,03273	0,01157	0,01157
75	0,07153	0,24000	0,48000	0,12716	-0,07153	0,32000	0,18000	0,64000	0,36000	0,31582	0,56198	0,19869	0,19869
100	0,04768	0,24000	0,48000	0,08476	-0,04768	0,32000	0,18000	0,64000	0,36000	0,14032	0,37460	0,13244	0,13244

Bibliography

Concerning a detailed description of the systems used during the comparisons, it will make the report too heavy as the systems' functionality is quite complicated.

Regarding the VNIIMS high-voltage measuring system participating the comparisons, we can note that this system is used both to measure the voltage of a switching impulse and, even more often, to measure DC voltage. The principle of operation of the system is described in sufficient detail in a number of VNIIMS publications, as well as the MIKES (former Helsinki University of Technology (HUT), Tubitak UME, etc. at various foreign conferences, International symposiums in the field of high voltage engineering (International Symposium on High Voltage Engineering (ISH), etc., for example:

- V. Jaroslowski (VNIIMS) publication «Some results of high voltage dividers calibration with DWINA-1000 measurement standard» in High Voltage Measurements and Calibration-Conference Proceedings, Arnhem-94, ERA (European Research Area) Rep. 94-0776, 1994;
- J. Hällström, M. Aro, A. Bergman, and V. Jaroslowski, "International intercomparison of direct and switching impulse voltage measurement systems with Zener-diod based reference, DWINA" CIGRE Working Group 33.03, Electra, vol. 179, pp. 24–37, 1998;
- Jari Hallstrom and Ahmet Merev publication «A Reference System for Measuring High-DC Voltage Based on Voltage Reference» в IEEE Transactions on instrumentation and measurement, vol. 64 № 1, January 2015.